

MOFÉM BALL VALVES FOR WATER AND GAS INSTALLATIONS

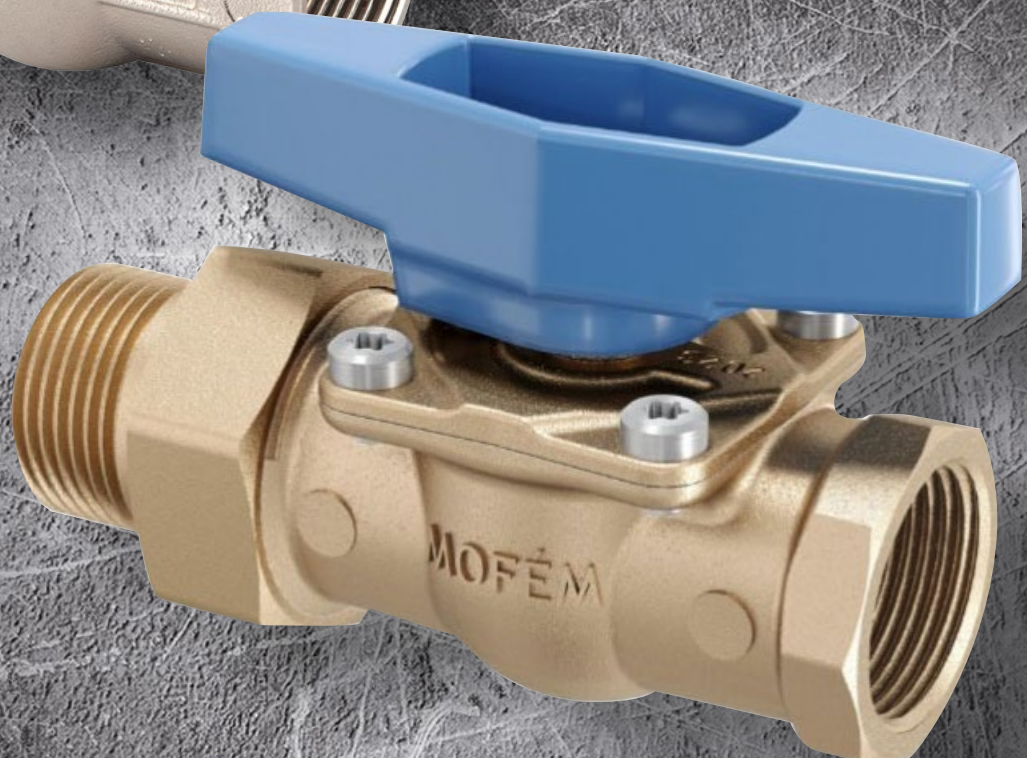



ABOUT US

STROHM MOFÉM PLC

- Founded in 1900
- Hungary's market leader sanitary products and industrial valves producer
- Direct export to 15 countries
- Sales of Mofém, Strohm Teka and Teka products
- Member of Strohm Group



STROHM GROUP

- Currently present in 50 countries
- 2 own factories
- More than 500 employees
- Specialised in the production and sales of taps, showers, shower trays, shower enclosures, wash-basins, bathtubs, toilets, bathroom furniture and bathroom accessories



PRODUCTION



Casting, machining, forging

Computer controlled casting machines, state-of-the-art CNC transfer machines.



Grinding, polishing

Automated grinding process with robot technology.



Electroplating

Fully automated plating plant.



Assembly

Operational and leakage tests on 100% of products.



Storage and transport

Warehouse system specialised for export and domestic trade.

CERTIFICATES

We are constantly developing our processes and investing in our factory while obtaining more and more certificates.



SPAIN



FRANCE



SINGAPORE



NORWAY



FRANCE



THAILAND



NEDERLANDS



RUSSIA



HUNGARY



HUNGARY



Produced for
over 50 years



Stainless steel screws



Reliable long term
operation



100 % pressure test
All ball valves are pressure
tested under water.



60
M+

Over 60 million
sold units



Repairable construction.

By removing the deck
repair and replacement of
components is possible,
without removing product
from the pipeline.



Mechanical strength.

No deformation during
assembly, no crack or break
of the ball valve body.

MOFÉM AHA BALL VALVES

Operating temperature

Min. 0 °C
Max. 90 °C for industrial water
Max. 65 °C for drinking water

Working pressure

16 bar

Applicable medium

Drinking water
Industrial water



Ball valve Female x Female

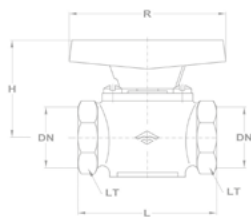

| Nominal dimension | | Dimensions in mm | | | | Female x Female |
|-------------------|------|------------------|----|-----|-----|-----------------|
| mm | inch | L | H | R | Lt. | Reference |
| 8 | 1/4" | 50 | 41 | 65 | 19 | 113-0001-00 |
| 10 | 3/8" | 50 | 41 | 65 | 22 | 113-0002-00 |
| 32 | 5/4" | 107 | 69 | 105 | 50 | 113-0051-00 |



Ball valve Female x Female

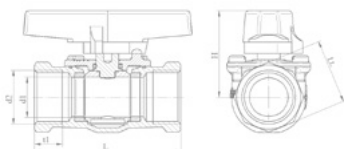

| Nominal dimension | | Dimensions in mm | | | | Female x Female |
|-------------------|------|------------------|----|----|-----|-----------------|
| mm | inch | L | H | t1 | Lt. | Reference |
| 12,5 | 1/2" | 60 | 38 | 13 | 25 | 113-0007-00 |
| 19 | 3/4" | 75 | 45 | 16 | 32 | 113-0018-00 |
| 25 | 1" | 90 | 54 | 17 | 40 | 113-0034-00 |



Ball valve Female x Female

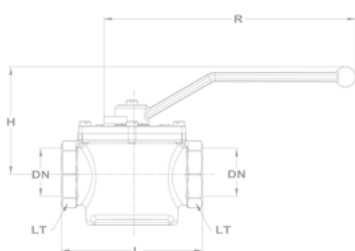

| Nominal dimension | | Dimensions in mm | | | | Female x Female |
|-------------------|------|------------------|------|-----|-----|-----------------|
| mm | inch | L | H | R | Lt. | Reference |
| 40 | 6/4" | 125 | 96,5 | 105 | 55 | 113-0052-00 |
| 50 | 2" | 159 | 113 | 105 | 70 | 113-0053-00 |



Ball valve Male x Female

• With extension

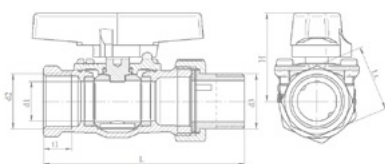

| Nominal dimension | | Dimensions in mm | | | | Male x Female |
|-------------------|------|------------------|----|----|-----|---------------|
| mm | inch | L | H | t1 | Lt. | Reference |
| 12,5 | 1/2" | 88 | 38 | 13 | 25 | 113-0009-00 |
| 19 | 3/4" | 107 | 45 | 16 | 32 | 113-0026-00 |
| 25 | 1" | 122 | 54 | 17 | 40 | 113-0038-00 |



Water master cock

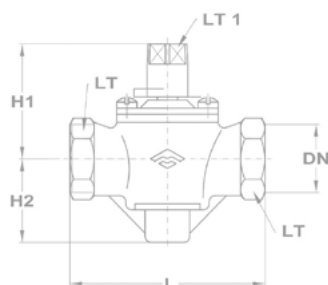

| Nominal dimension | | Dimensions in mm | | | | Female x Female | |
|-------------------|------|------------------|------|----|----|-----------------|-------------|
| mm | inch | Lt1 | L | H1 | H2 | Lt | Reference |
| 20 | 3/4" | 14 | 86,5 | 56 | 45 | 32 | 113-0019-00 |



MOFÉM FLEXUM GAS BALL VALVES

Operating temperature

Min. -20 °C
Max. 60 °C

Working pressure

5 bar

Applicable medium

Gas (PB, ethane, butane, methane, natural gas etc.)



100 % pressure test

All ball valves are pressure tested under water.



Gas ball valve

- Female x Female

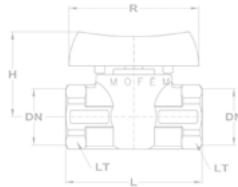

| Nominal dimension | Dimensions in mm | | | | Female x Female |
|-------------------|------------------|----|----|----|-----------------|
| | DIN | L | H | R | Lt. |
| 1/2" | 67 | 43 | 60 | 27 | 113-0065-40 |
| 3/4" | 76 | 49 | 75 | 32 | 113-0067-40 |
| 1" | 92 | 58 | 90 | 39 | 113-0069-40 |



Gas ball valve

- Male x Female

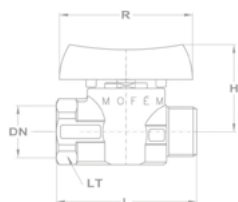

| Nominal dimension | Dimensions in mm | | | | Male x Female |
|-------------------|------------------|----|----|----|---------------|
| | DIN | L | H | R | Lt. |
| 1/2" | 69 | 36 | 60 | 25 | 113-0074-40 |
| 3/4" | 78 | 49 | 75 | 32 | 113-0095-40 |



Gas ball valve with with thermal closing valve

113-0074-35

- Gas ball valve male x female
- Thermal closing valve



Angle valves



Angle valve

1/2" - 1/2" 163-0002-00

1/2" - 3/8" 163-0006-00

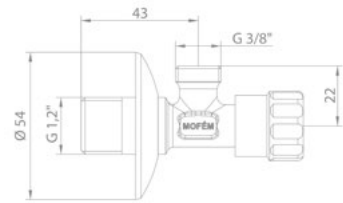

Combinated angle valve

163-0015-01

- Washmachine/washingmachine connection - 3/4"
- Washbasin mixer connection - 3/8"
- Wall connection - 1/2"
- Adjustable, removable headpart
- With tube connection

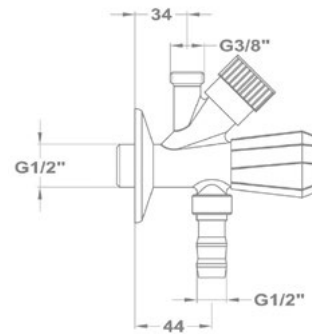

Angle valve with filter

163-0010-10

- With stainless steel, removable and cleanable filter
- Connection: 3/8"

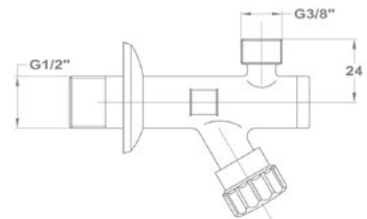

Washingmachine valve

163-0014-00

- Chrome surface
- 1/2" - 3/4"

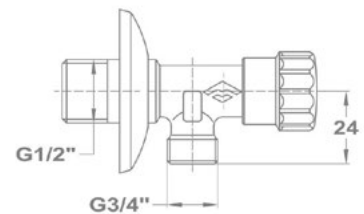



STROHM MOFÉM Zrt.
H-9200 Mosonmagyaróvár, Terv u.92
Hungary

Phone: +36/96 574 500
www.mofem.hu